

PRODUCT DESCRIPTION

The Semiconductor LP2950 and LP2951 are a low power voltage regulators. These devices are excellent choice for use in battery-powered applications such as cordless telephone, radio control systems, and portable computers.

The LP2950 and LP2951 features very low quiescent current (75 μ A Typ.) and very low drop output voltage (Typ. 40 μ V at light load and 380 mV at 100 mA). This includes a tight initial tolerance of 0.5% typ., extremely good load and

line regulation 0.05% typ. and very low output temperature coefficient, making the LP2950/LP2951 useful as a low-power voltage reference. Other key additional feature of this unregulated input voltage transient of -20V below ground (reverse battery).

The error flag output feature is used as power-on reset for warn of a low output voltage, due to following batteries on input. Other feature is the logic-compatible shutdown input which enable the regulator to be

switched on and off. The LP2950 is offered in 3-pin TO-92 package compatible with other 5 volt regulators. The LP2951 is available in 8-pin plastic, SOP-8 package.

The regulator output voltage may be pin-strapped for a 5 volt of programmed from 1.24 volt to 29 volts with external pair of resistors. Using as design, processing and testing techniques make our LP2950 and LP2951 superior over similar products.

FEATURES

- Output accuracy 5V, 150 mA output
- Very low quiescent current
- Low dropout voltage
- Extremely tight load and line regulation
- Very low temperature coefficient
- Need only 1 μ F for stability
- Unregulated DC input can withstand -20V reverse battery and +60V positive transients
- Direct replacement for LP2950/LP2951 sockets

LP2951 VERSIONS ONLY

- Error Flag warns of output dropout
- Logic-Controlled electronic shutdown
- Output programmable from 1.24 to 29V

ORDERING INFORMATION

TO-92 3-PIN	PLASTIC SOP 8-PIN	OPER. TEMP. RANGE.
LP2950ACT		IND.
LP2950CT		IND.
	LP2951ACS	IND.
	LP2951CS	IND.

APPLICATIONS

- Battery powered systems
- Cordless telephones
- Radio control systems
- Portable/Palm top / Notebook computers
- Portable consumer equipment
- Portable instrumentation
- Avionics
- Automotive Electronics
- SMPS Post-Regulator
- Voltage Reference

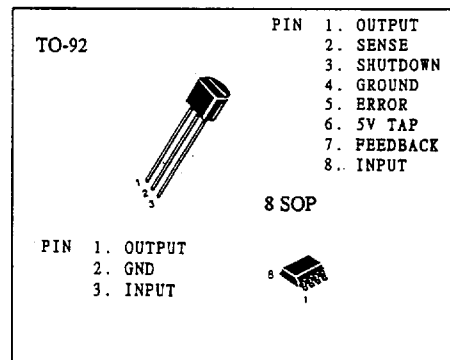

ABSOLUTE MAXIMUM RATINGS

Power Dissipation.....Internally Limited	Input Supply Voltage.....-20 to +60V
Lead Temp.(Soldering, 5 Seconds).....260°C	Feedback Input Voltage.....-1.5 to +30V
Storage Temperature Range.....-65 to +150°C	Shutdown Input Voltage.....-0.3 to +30V
Operating Junction Temperature Range	Error Comparator Output.....-0.3 to +30V
LP2951.....-55 to +150°C	ECD Rating is to be determined
LP2950AC/LP2950C	
LP2951AC/LP2951C.....-40 to +125°C	

ELECTRICAL CHARACTERISTICS at $V_i=15V$, $T_a=25^\circ C$, unless otherwise noted.

PARAMETER	CONDITIONS (Note 2)	LP2950AC LP2951AC			LP2950C LP2951C			UNITS
		Min.	Typ.	Max	Min.	Typ.	Max	
Output Voltage	$T_j=25^\circ C$ $-25^\circ C \leq T_j \leq 85^\circ C$ Full Operating Temperature	4.975 4.95 4.94	5.0	5.025 5.05 5.06	4.95 4.93 4.94	5.0 5.075 5.085	5.05 5.075 5.085	V
Output Voltage	$100\mu A \leq I_L \leq 100mA$ $T_j \leq T_{jMAX}$	4.93		5.07	4.925		5.075	V
Output Voltage Temperature Coefficient	(Note 1)		20			50		ppm/°C
Line Regulation (Note 3)	$6V \leq V_{in} \leq 30V$ (Note 4)		0.03	0.2		0.04	0.2	%
Load Regulation (Note 3)	$100\mu A \leq I_L \leq 100mA$		0.04	0.1		0.1	0.2	%
Dropout Voltage (Note 5)	$I_L=100\mu A$ $I_L=100mA$ $I_L=150mA$		40 250 300	80 300 450		40 250 300	80 300 450	mV mV mV
Ground Current	$I_L=100\mu A$ $I_L=100mA$ $I_L=150mA$		75 1.7 4	120 2.5 6		75 1.7 4	120 2.5 6	μA mA mA
Dropout Ground Current	$V_{in}=4.5V$ $I_L=100\mu A$		110	170		110	170	μA
Current Limit	$V_{out}=0$		160	200		160	200	mA
Thermal Regulation			0.05	0.2		0.05	0.2	%/W
Output Noise, 10Hz to 100KHz	$C_1=1\mu F$ $C_1=200\mu F$ $C_1=13.3\mu F$ (Bypass= $0.01\mu F$ pins 7 to 1(LP2951))		430 160 100			430 160 100		μV_{rms}
8-Pin Versions only		LP2951AC			LP2951C			
Reference Voltage		1.22	1.235	1.25	1.216	1.235	1.254	V
Reference Voltage	Over Temperature(Note 6)	1.19		1.27	1.18		1.28	V
Feedback Pin Bias Current			20	40		20	40	nA
Reference Voltage Temperature Coefficient	(Note 7)		20			50		ppm/°C
Feedback Pin Bias Current Temperature Coefficient			0.1			0.1		nA/°C

PARAMETER	CONDITIONS (Note2)	LP2950AC LP2951AC			LP2950C LP2951C			UNITS
		Min.	Typ.	Max.	Min.	Typ.	Max.	
ERROR Comparator								
Output Leakage Current	$V_{oh}=30V$		0.01	1			1	μA
Output Low Voltage	$V_{in} = 4.5V$ $I_{ol} = 400\mu A$		150	250		150	250	mV
Upper Threshold Voltage	(Note 8)	40	60		40	60		mV
Power Threshold Voltage	(Note 8)		75	95		75	95	mV
Hysteresis	(Note 8)		15			15		mV
Shutdown Input								
Output Logic Voltage	Low (Regulator ON) High(Regulator OFF)	2	1.3	0.7	2	1.3	0.7	V
Shut down Pin Input Current	$V_s = 2.4V$ $V_s = 30V$		30 450	50 600		30 450	50 600	μA
Regulator Output Current in Shutdown	(Note 9)		3	10		3	10	μA

Note 1: Output or reference voltage temperature coefficients defined as the worst case voltage change divided by the total temperature range.

Note 2: Unless otherwise specified all limits guaranteed for $T_j=25^\circ C$, $V_{in} = 6V, I_L=100\mu A$ and $C_L=100\mu F$. Additional conditions for the 8-pin versions are feedback tied to 5V tap output Sense ($V_{out} = 5V$) and $V_{shutdown} \leq 0.8V$.

Note 3: Regulation is measured at constant junction temperature, using pulse testing with a low duty cycle. Changes in output voltage due to heating effects are covered under the specification for thermal regulation.

Note 4: Line regulation for the LP2951 is tested at $150^\circ C$ for $I_L=1mA$. For $I_L=100\mu A$ and $T_j=125^\circ C$, line regulation is guaranteed by design to 0.2%. See typical performance characteristics for line regulation versus temperature and load current.

Note 5: Dropout Voltage is defined as the input to output differential at which the output voltage drops 100mV below its nominal value measured at 1V differential at very low value of programmed output voltage, the minimum input

supply voltage of 2V (2.3V over temperature) must be taken in to account.

Note 6: $V_{ref} \leq V_{out} \leq (V_{in}-1V), 2.3 \leq V_{in} \leq 30V, 100\mu A \leq I_L \leq 100mA, T_j \leq T_{jMAX}$.

Note 7: Output or reference voltage temperature coefficient is defined as the worst case voltage change divided by the total temperature range.

Note 8: Comparator thresholds are expressed in terms of a voltage differential at the feedback terminal below the nominal reference voltage measured at 6V input. To express these thresholds in terms of output voltage change, multiply by the error amplifier gain = $V_{out}/V_{ref} = (R1+R2)/R2$. For example, at a programmed output voltage of 5V, the Error output is guaranteed to go low when the output drops by $95 mV \times 5V/1.235 = 384mV$. Thresholds remain constant as a percent of V_{out} as V_{out} is varied. with the dropout warning occurring at typically 5% below nominal, 7.5% guaranteed.

Note 9: $V_{shutdown} \geq 2V, V_{in} \leq 30V, V_{out} = 0$, Feedback pin tied to 5V Tap.

APPLICATION HINTS EXTERNAL CAPACITORS

External Capacitors

For the stability of the LP2950/LP2951 requires a $1.0 \mu\text{F}$ or greater capacitor between output and ground. Oscillation could occur without this capacitor. The tantalum or aluminum electrolytic works fine; could use the FILP type but are not cost efficient. For the operation of below -25°C solid tantalum is recommended since the many aluminum type have electrolytes the freeze at about -30°C . The ESR of about 5Ω or less and resonant frequency above 500kHz are most important parameter in the value of Capacitor. The Capacitors value can be increased without any limit.

At lower values of output current,

less output capacitance is required for stability. For the currents below 10mA the value of capacitor can be reduce to $0.33\mu\text{F}$ and $0.1\mu\text{F}$ for 1mA . More output capacitance needed for the 8-pin version at voltage below 5V since it runs the error amplifier at lower gain. At worst case $3.3\mu\text{F}$ or greater must be used for condition of 100mA load at 1.235V output.

The LP2950 not like other low dropout regulators will remain stable and regulation with no load in addition to the internal voltage divider. This feature very important in application like CMOS RAM keep-alive. The LP2951 output

voltage setting with minimum load of $1\mu\text{A}$ and external resistors.

If at the input of LP2950/LP2951 connected to battery or between AC filter capacitor and input is 10 inches wire then $1\mu\text{F}$ tantalum or aluminum electrolytic capacitor should be connected between input and ground.

Instability can occur if stray capacitor to feedback terminal pin 7 of the LP2951. This could cues more problem more when using higher value of external to set the output voltage. To fix this problem the 100pF capacitor between output and feedback and increasing output capacitance to $3.3\mu\text{F}$.

ERROR DETECTION COMPARATOR OUTPUT

The Compactor produces a logic low output whenever the LP2951 output falls of regulation by more than around 5% . This is around 60mV offset divided by the 1.235 reference voltage. Thus trip remains 5% below nominal regardless of the programmed output voltage of the regulator. the figure 1 shows the timing diagram depicting the ERROR signal and the regulator output voltage as the LP2951 input is ramped up and down. the ERROR

signal becomes low at around 1.3V input, it goes high around 5V input, (input voltage at which $V_{\text{out}} = 4.75$). The LP2951 dropout voltage depending on the load, the input voltage trip point around 5V will vary with load current. The output voltage trip point is around 4.75V it does not change with load.

The error comparator has an open-collector output which requires an external pull-up resistor.

Depending on the system requirement the resistor maybe returned to 5V output or other supply voltage depending to the system requirements. For determining the size of the resistor, note that the output is sinking $400\mu\text{A}$, this value adds to battery drain in a low better condition, recommended values 100K to $1\text{M}\Omega$. If the output is unused this resistor is not required.

PROGRAMMING THE OUTPUT VOLTAGE OF LP2951

The LP2951 output voltage is programmable for any value from its reference voltage of 1.235 volt and its maximum rating of 30 volt. For example, for 5 volt, you need to pin-strapped and use the internal voltage divider by tying pin 1 to 2 and pin 7 to pin 6. Refer to Figure 2, there are two external resistors required for this programming.

Refer to the below equation for the programming of the output voltage:

$$V_{out} = V_{ref} \times (1 + R_1/R_2) + I_{FB}R_1$$

The V_{ref} is 1.235 and I_{FB} is the feedback bias current, nominally -20 nA. The minimum recommended load current of 1 μ A forces an upper limit of 1.2M Ω on the value of R_2 . If no load is presented, the I_{FB} produces an error of typically 2% in V_{out} which

may be eliminated at room temperature by trimming R_1 . To improve the accuracy, you choose the value of $R_2 = 100K$ and this reduces the error by 0.17% and increases the resistor program current by 12 μ A. The LP2951 typically draws 60 μ A at no load with pin 2 open-circuit, and this value does not look much.

REDUCING OUTPUT NOISE

It could be an advantage to reduce the AC noise present at the output. One way is to reduce the regulator bandwidth by increasing the value of the output capacitor. This is the only method that noise could be reduced on the LP2950 but is relatively inefficient, as increasing the capacitor from 1 μ F to 220 μ F only decreases

the noise from 430 μ V to 160 μ V rms for a 100 kHz bandwidth at 5 volt output.

Noise could also be reduced by fourfold by a bypass capacitor across R_1 since it reduces the high frequency gain from 4 to unity. Pick $C_{BYPASS} = 1 / (2\pi R_1 \times 200Hz)$ or choose 0.01 μ F. When doing this,

the output capacitor must be increased to 3.3 μ F to maintain stability. These changes reduce the output noise from 430 μ V rms for a 100 kHz bandwidth 5 volt output. With the bypass capacitor added, noise no longer scales with output voltage so that improvements are more dramatic at higher output voltages.

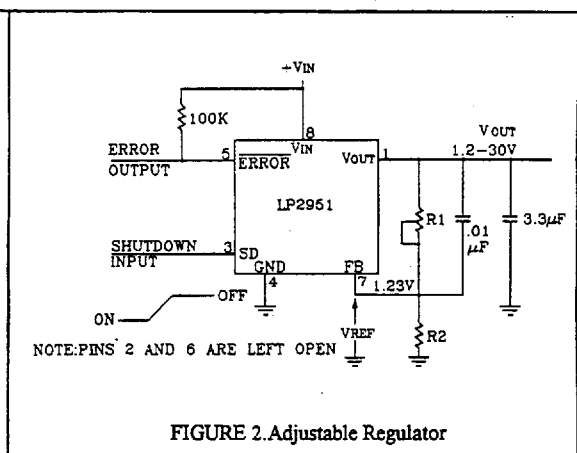
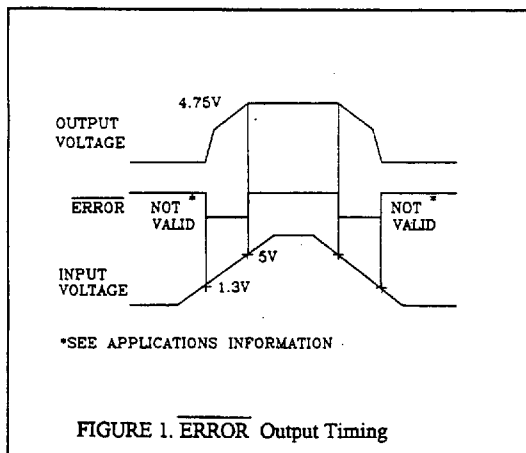

BLOCK DIAGRAM AND TYPICAL APPLICATIONS

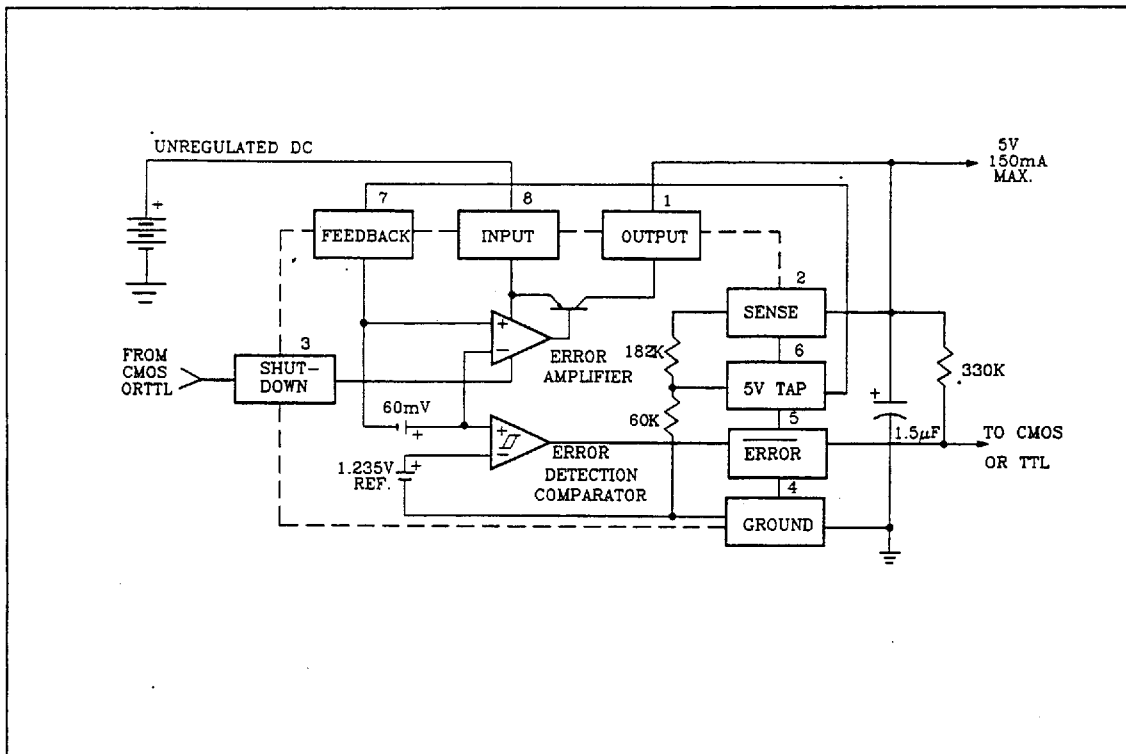

Typical Performance Characteristics

Input Current

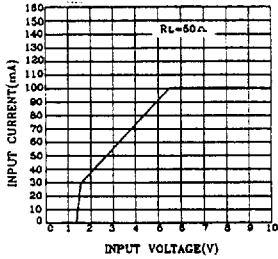

Output Voltage vs. Temperature of 3 Representative Units

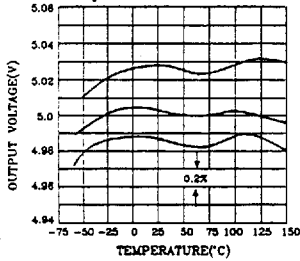

Ground Pin Current

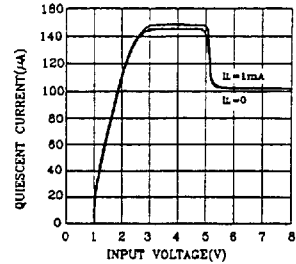

Short Circuit Current

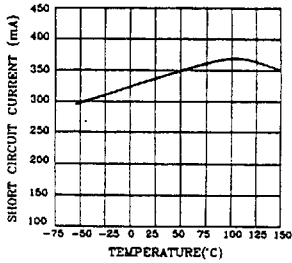

Dropout Voltage

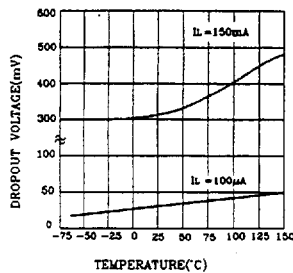

Dropout Voltage

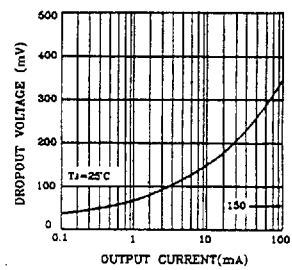

Ground Pin Current

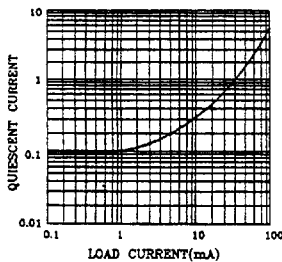

Dropout Characteristics

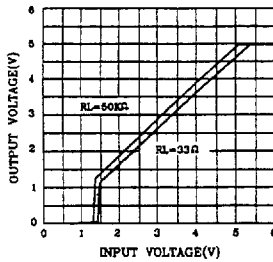

Input Current

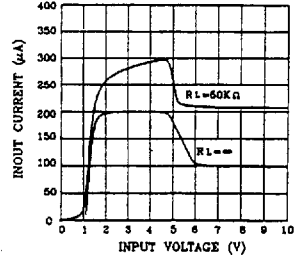

Ground Pin Current

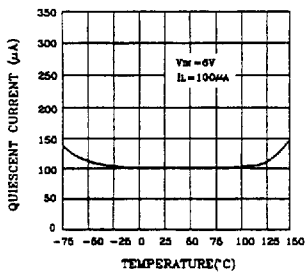

Ground Pin Current

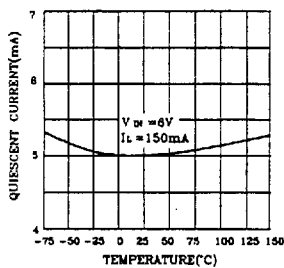

Ground Pin Current

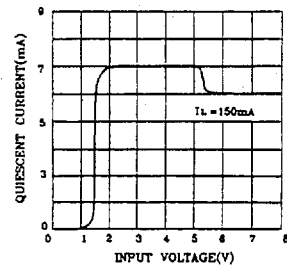

Typical Performance Characteristics

Shutdown Threshold Voltage

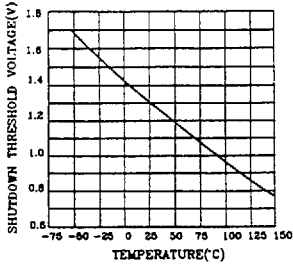

Line Regulation

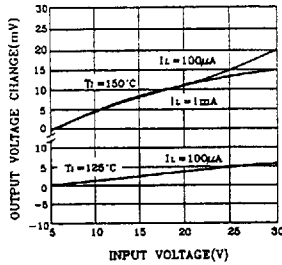

Maximum Rated Output Current

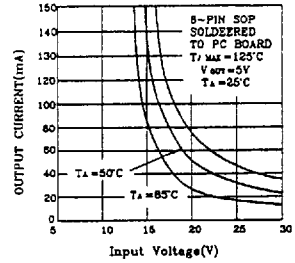

Load Transient Response

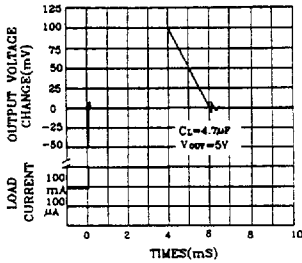

Load Transient Response

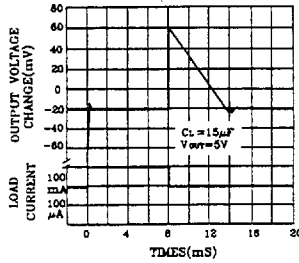

Enable Transient

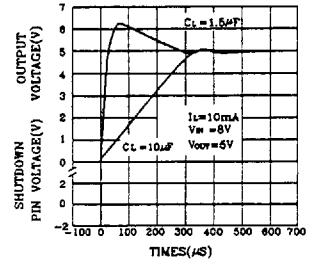

Error Comparator Output

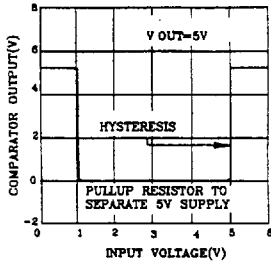

Comparator Sink Current

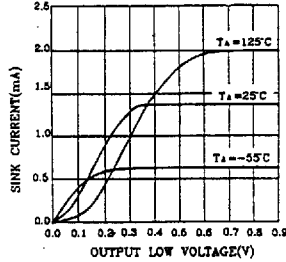

Line Transient Response

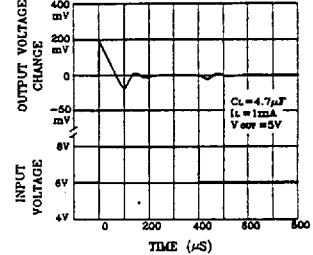

Minimum Operating Voltage

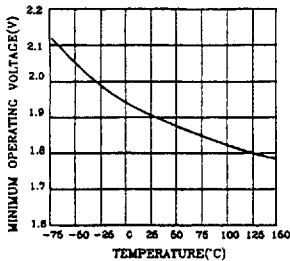

Feedback Bias Current

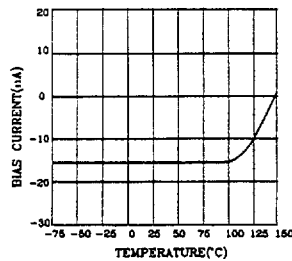

Feedback Pin Current

